

xD

2010

QUICK REFERENCE GUIDE

GET INFORMED.
ROLL.



what moves you

2010 Scion xD

This *Quick Reference Guide* is a summary of basic vehicle operations. It contains brief descriptions of fundamental operations so you can locate and use the vehicle's main equipment quickly and easily.

The *Quick Reference Guide* is not intended as a substitute for the *Owner's Manual* located in the vehicle's glove box. We strongly encourage you to review the *Owner's Manual* and supplementary manuals so you will have a better understanding of the vehicle's capabilities and limitations.

Your dealership and the entire staff of Toyota Motor Sales, U.S.A., Inc. wish you many years of satisfied driving in your new Scion xD.

! A word about safe vehicle operations

This *Quick Reference Guide* is not a full description of Scion xD operations. Every Scion xD owner should review the *Owner's Manual* that accompanies this vehicle.

Pay special attention to the boxed information highlighted in color throughout the *Owner's Manual*. Each box contains safe operating instructions to help you avoid injury or equipment malfunction.

All information in this *Quick Reference Guide* is current at the time of printing. Toyota reserves the right to make changes at any time without notice.

INDEX

OVERVIEW

Engine maintenance	7
Fuel tank door release and cap	6
Hood release	7
Indicator symbols	4-5
Instrument cluster	4
Instrument panel	2-3
Keyless entry¹	6
Light control-Instrument panel	7

FEATURES/OPERATIONS

Air Conditioning/Heating	12
Automatic Transmission	8
Bottle holders	15
Clock	13
Cruise control	11
Cup holders	15
Lights & turn signals	10
Multi-information display	14
Parking brake	8
Power outlet	15
Seat adjustments	9
Seat-Folding down rear seat	9
Seats-Head restraints	8
Steering wheel switches	14
Tilt steering wheel	12
USB adapter/AUX audio jack	13
Windows	11
Window wipers & washers	10

SAFETY AND EMERGENCY FEATURES

Door locks	16
Doors-Child safety locks	16
Seat belts	16
Seat belts-Shoulder belt anchor	16
Spare tire & tools	17
Tire Pressure Monitoring (warning) System	17

¹ Visit your Toyota dealer for information on customizing this feature.

OVERVIEW

Instrument panel

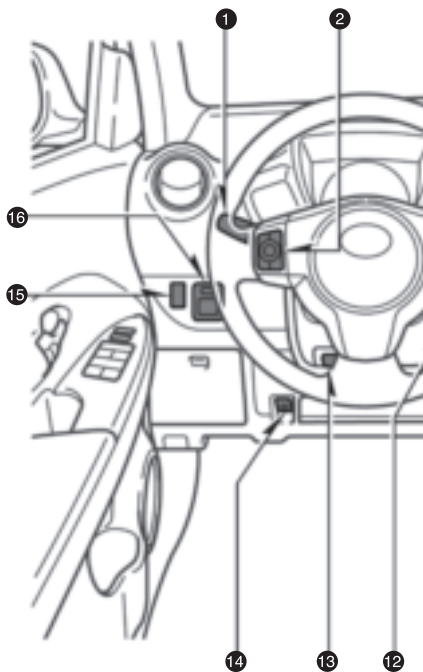

- ① Headlight and turn signal controls
- ② Steering wheel audio controls*
- ③ Wiper and washer controls
- ④ Emergency flasher button
- ⑤ Clock
- ⑥ Front passenger occupant classification indicator/Front passenger seatbelt reminder light
- ⑦ Air Conditioning controls
- ⑧ Rear window defogger button

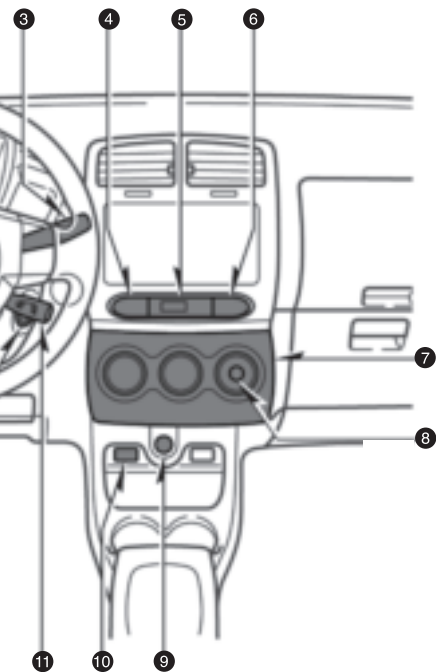

- 9 12V DC Power outlet
- 10 USB adapter/AUX audio jack*
- 11 Cruise control
- 12 Ignition switch
- 13 Tilt steering lock release
- 14 Tire Pressure Monitoring (warning) System reset
- 15 Instrument panel light control
- 16 Power rearview mirror controls





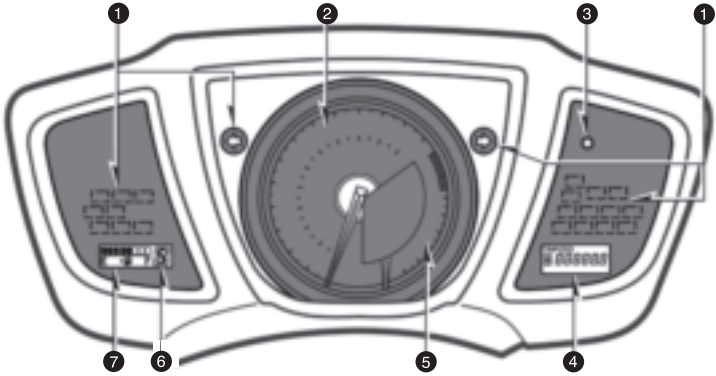



* For details, refer to the *SCION Audio System, Owner's Manual* or *SCION Navigation System Owner's Manual*.

Instrument cluster



















- ❶ Service indicator and reminder
- ❷ Speedometer
- ❸ MODE switch
- ❹ Multi-information display
- ❺ Tachometer
- ❻ Shift position indicator
- ❼ Fuel gauge

Indicator symbols

	Brake system warning ¹
	Driver seatbelt reminder ¹ (alarm will sound if speed is over 12 mph)
	Front passenger seatbelt reminder ¹ (alarm will sound if speed is over 12 mph)
	Charging system warning ¹
	Malfunction/Check Engine indicator ¹
	Low engine oil pressure warning ¹
	Open door warning ¹
	Airbag SRS warning ¹

¹ For details, refer to "Service reminder indicators and warning buzzers," Section 1-6, 2010 Owner's Manual.

² For details, refer to "Engine coolant temperature indicator and warning light," Section 1-6, 2010 Owner's Manual.

	Low Tire Pressure Warning ¹
	Low windshield washer fluid level warning ¹
	Low engine coolant temperature indicator ²
	High engine coolant temperature warning ¹
	Engine oil replacement reminder ¹
	Front passenger occupant classification indicator
	Headlight low beam indicator
	Headlight high beam indicator
	Turn signal indicator
	Low fuel level warning ¹
	Slip indicator ¹
	Vehicle Stability Control OFF indicator
	Traction Control OFF indicator
	Cruise control indicator ³
	Electric power steering system warning ¹
	Anti-lock Brake System warning ¹

³ If this light flashes, refer to "Cruise control," Section 1-7, 2010 Owner's Manual.

Keyless entry

Locking operation



Push 

Unlocking operation



Push ONCE: Driver door 
TWICE: ALL doors

NOTE: If a door is not opened within 30 seconds of unlocking, all doors will relock for safety.

Panic button



Push and hold 

Fuel tank door release and cap

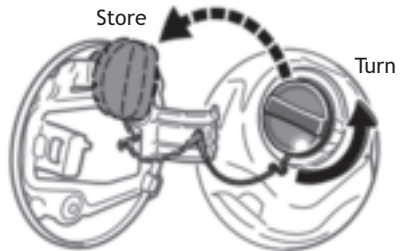
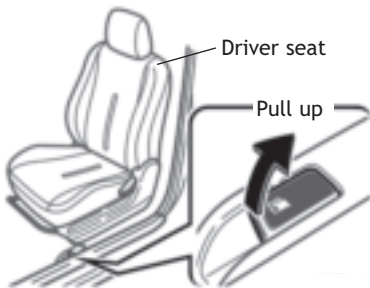

NOTE: Tighten until one click is heard. If the cap is not tightened enough, Check Engine "  " indicator may illuminate.

Light control-Instrument panel

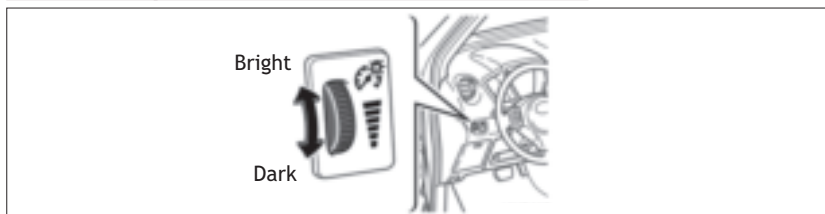

Hood release



Engine maintenance

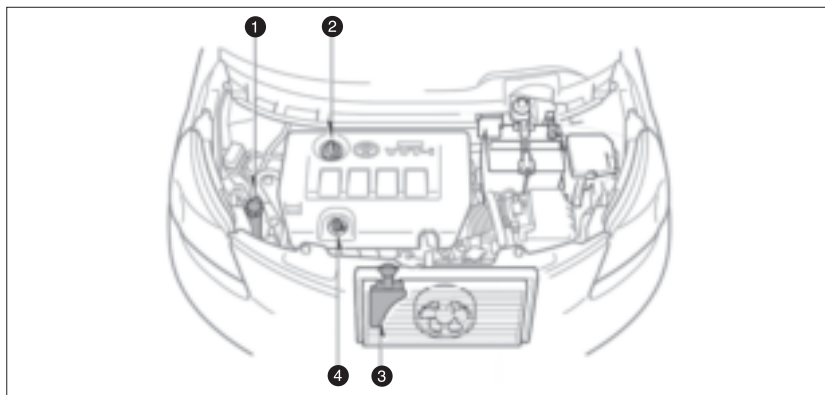

- ① Windshield washer fluid tank
- ② Engine oil filler cap
- ③ Engine coolant reservoir
- ④ Engine oil level dipstick

NOTE: Regularly scheduled maintenance, including oil changes, will help extend the life of your vehicle and maintain performance. Please refer to the "Warranty Maintenance Guide."

FEATURES/OPERATIONS

Automatic Transmission (if equipped)

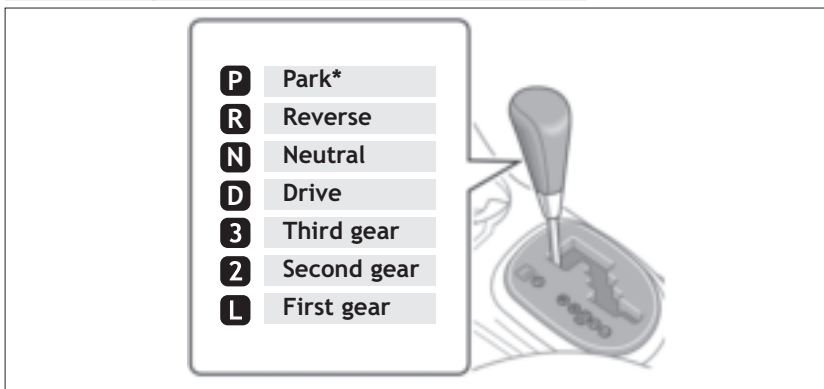

* The engine switch must be "ON" and the brake pedal depressed to shift from Park.

Downshifting increases power going uphill, or provides engine braking downhill. For best fuel economy during normal driving conditions, always drive with the shift lever in the "D" position.

Parking brake

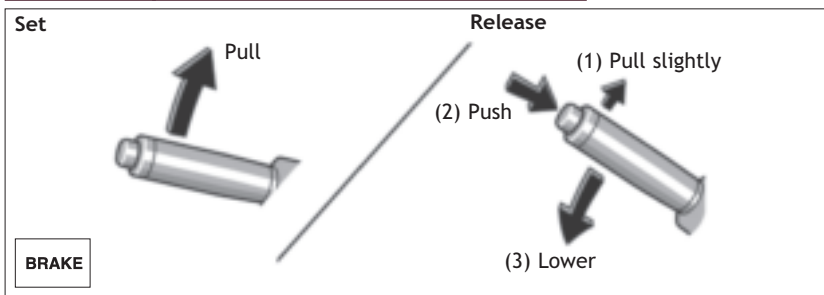

Seats-Head restraints

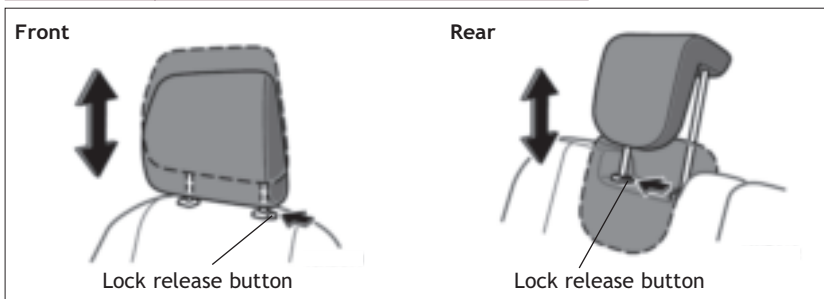

Seat adjustments

Front



Rear

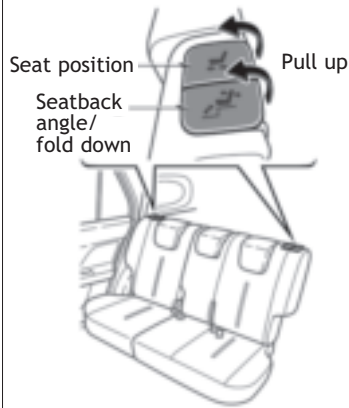

Seat-Folding down rear seat

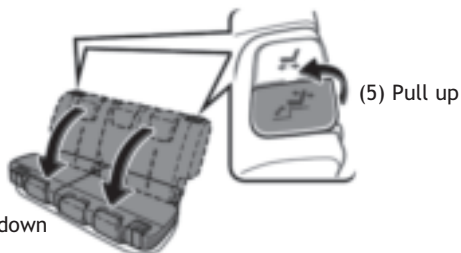
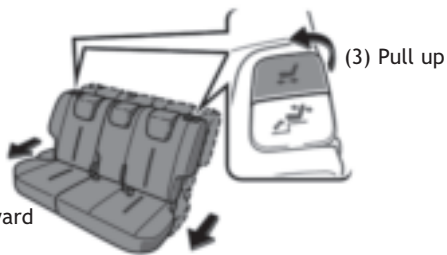
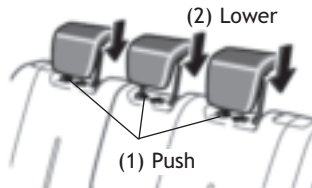

Lights & turn signals

Headlights

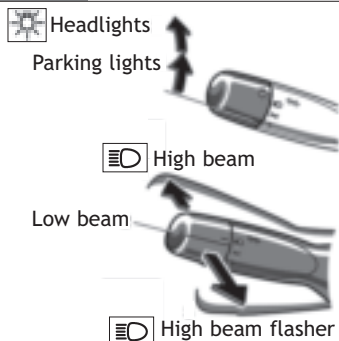

Turn signals

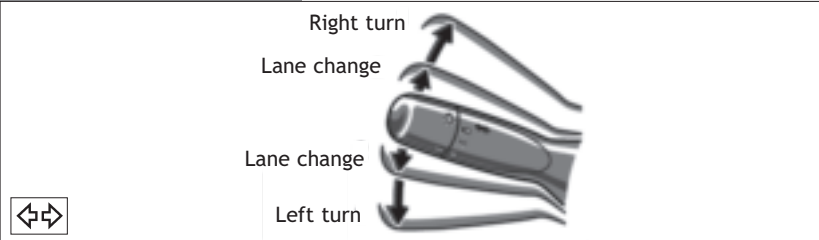

Window wipers & washers

Front

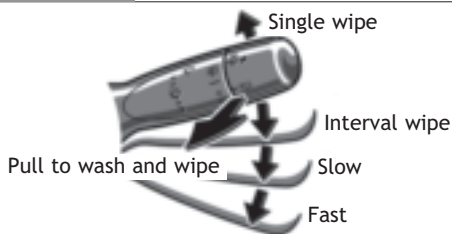

Rear

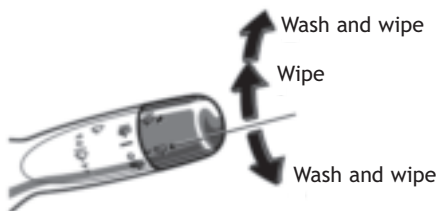

Windows

Driver side

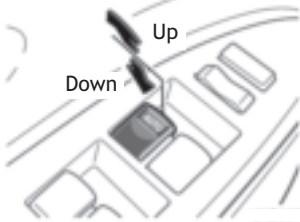

Window lock switch

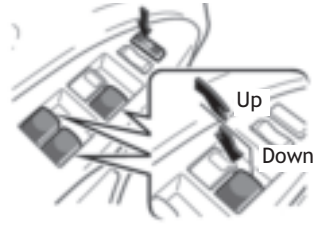

Automatic down operation (driver side only)

Push the switch completely down and release to fully open. To stop window midway, lightly pull the switch up.

Window lock switch Deactivates all passenger windows. Driver's window remains operable.

Cruise control

System ON/OFF

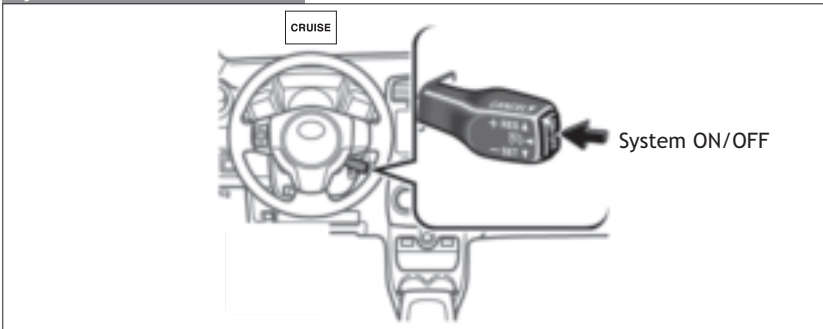

Functions

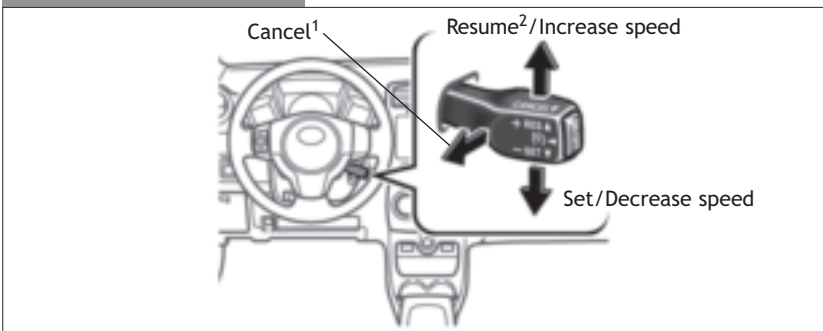

¹ The set speed may also be cancelled by depressing the brake pedal.

² The set speed may be resumed once vehicle speed reaches 25 mph.

Tilt steering wheel



Hold wheel, push lever down, set angle and return lever.

NOTE: Do not attempt to adjust while the vehicle is in motion.

Air Conditioning/Heating

A line drawing of a car's climate control panel. It features three circular dials and several buttons. Numbered callouts 1 through 6 point to specific controls: 1 points to the A/C button, 2 to the fan speed dial, 3 to the rear window defogger button, 4 to the temperature selector dial, 5 to the fresh/recirculated air selector dial, and 6 to the airflow vent selector dial.

- 1 Air Conditioning ON/OFF
Use fresh air to quickly cool interior, then change to recirculate for cooler air.
- 2 Fan speed
- 3 Rear window defogger
- 4 Temperature selector
- 5 Fresh or recirculated cabin air
- 6 Airflow vent
In “” or “” mode, use with the air intake selector position in “” to reduce window fogging.

USB adapter/AUX audio jack

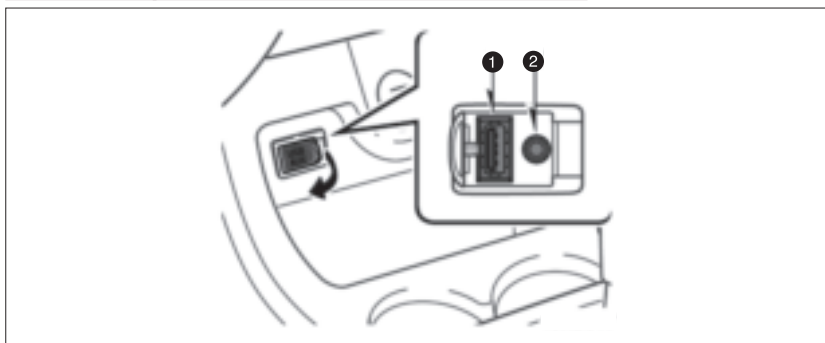

1 USB adapter

By connecting a USB-compatible portable audio device or USB memory to the USB adapter, you can listen to music from the portable audio device or USB memory through the vehicle's speaker system.

2 AUX audio jack

By inserting a mini plug into the AUX audio jack, you can listen to music from a portable audio device through the vehicle's speaker system while in AUX mode.

If you do not have a SCION genuine audio system, you will not be able to use the AUX audio jack/USB adapter.

Refer to the *SCION Audio or Navigation System Owner's Manual* for more details.

Clock

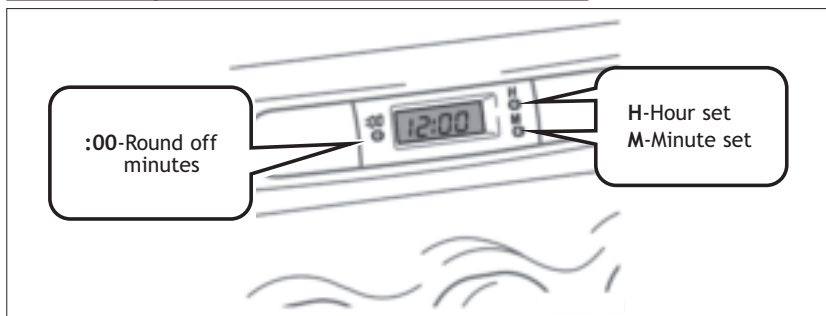

Steering wheel switches

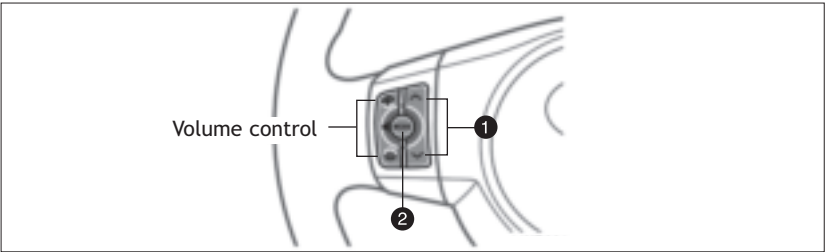

- ① “**v ^**”
 - In **radio mode** Push to select a preset station; push and hold to seek the next strong station.
 - In **CD mode** Push to skip up or down to a next/previous track.
- ② “**MODE**”
 - Push to turn audio ON and select an audio mode. Push and hold to turn the audio system OFF.

Refer to the *SCION Audio or Navigation System Owner’s Manual* for more details.

Multi-information display

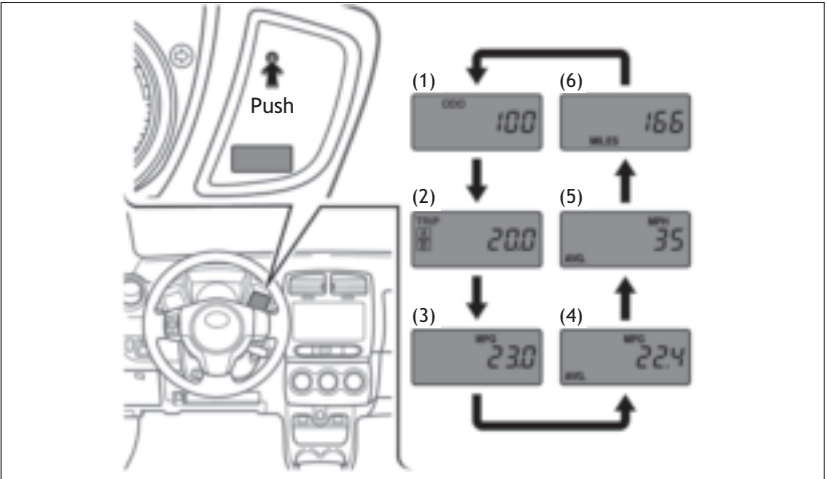

Push button to change information in the following succession:

- (1) Odometer
- (2) Trip meters
- (3) Current gas mileage (MPG)
- (4) Average gas mileage (AVG/MPG)
- (5) Average vehicle speed from engine start (AVG/MPH)
- (6) Miles left on remaining fuel (RANGE/MI)

Power outlet

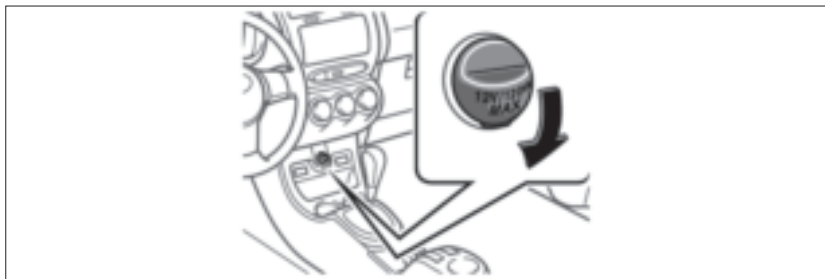

Designed for car accessories. Key must be in the "ACC" or "ON" position for use.

Bottle holders

Front



Rear



Cup holders

Front

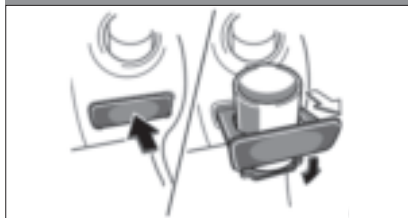

Rear

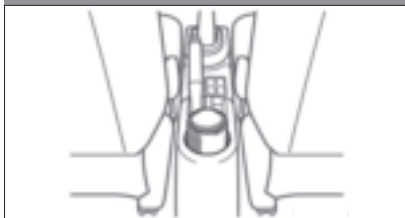

Center



SAFETY AND EMERGENCY FEATURES

Door locks



Doors-Child safety locks

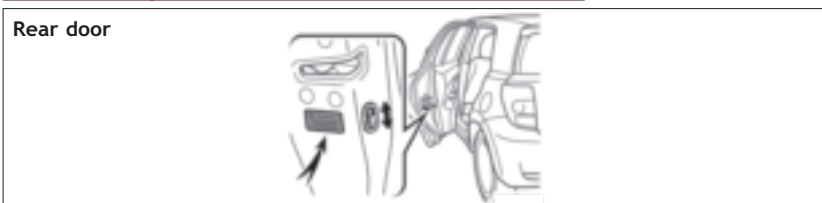

Moving the lever to "LOCK" will allow the door to be opened only from the outside.

Seat belts-Shoulder belt anchor

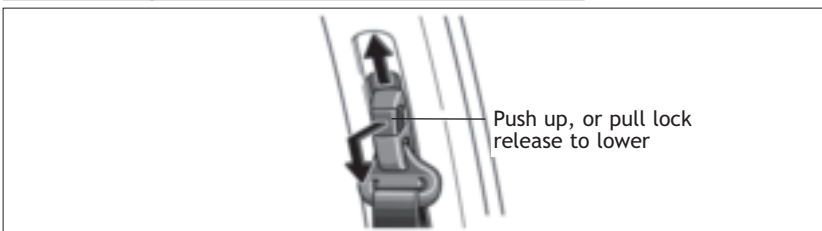

Seatbelts

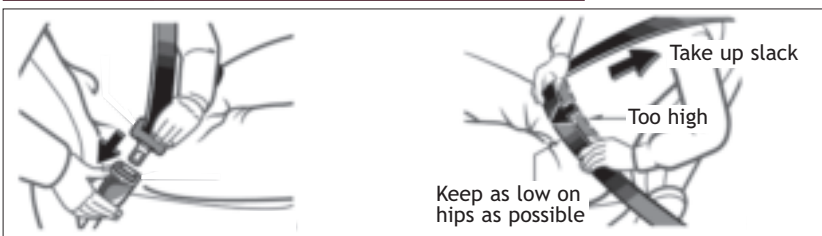

If belt is fully extended, then retracted even slightly, it cannot be re-extended beyond that point, unless fully retracted again. This feature is used to help hold child restraint systems securely.

To find more information about seatbelts, and how to install a child restraint system, refer to the *Owner's Manual*.

Tire Pressure Monitoring (warning) System



System reset initialization

1. Push and hold "SET" button until the indicator blinks three times.
2. Wait several minutes to allow initialization to complete.

After adjusting tire pressures, or after tires have been rotated or replaced, turn the ignition switch to "ON" and press and hold the "SET" button until indicator blinks three times. Let the vehicle sit for a few minutes to allow initialization to complete.

Refer to the load label on the door jamb or the *Owner's Manual* for tire inflation specifications.

If the tire pressure indicator flashes for more than 60 seconds and then remains on, take the vehicle to your local Toyota dealer.

NOTE: The warning light may come on due to temperature changes or changes in tire pressure from natural air leakage. If the system has not been initialized recently, setting the tire pressures to factory specifications should turn off the light.

Spare tire & tools

Tool and spare tire location

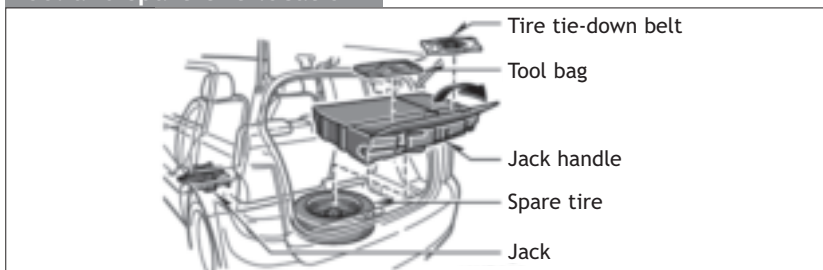

Removing the spare tire

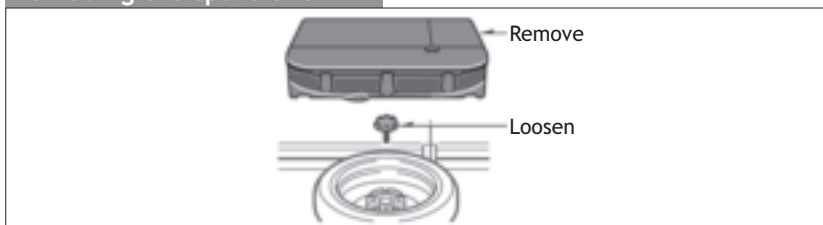

Refer to the *Owner's Manual* for jack positioning and tire changing procedures.

EMAIL

www.scion.com

→ Contact

-

CHAT

www.scion.com

→ Have a Question?

→ Contact

-

PHONE

1.866.70.SCION

-

MAIL

SCION

19001 S. Western Ave.

D102, P.O. Box 2742

Torrance, CA 90509-2742

USA

-

WEB

www.scion.com

-



Mixed Sources

Product group from well-managed forests, controlled sources and recycled wood or fiber

www.fsc.org Cert no. SGS-COC-005612
© 1996 Forest Stewardship Council



© 2009 Scion, a marque of Toyota Motor Sales, U.S.A., Inc.

Printed in U.S.A. 7/09

08-TCS-03077

00505-QR610-XD